

Data Sheet

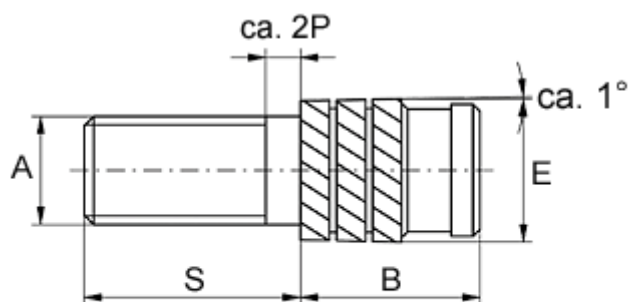

Article number: 12856000040860
Description: KLEE-coil 856 000 040.860
M4 Brass

Measures



Gevindlængde = $S - 2P$
P = stigning

Male thread A	= M4x0,7
Min distance to edge	= 2.5
Mounting length B	= 7.4
Outer diameter E	= 5.80
Pin length S	= 16
Recommended bore diameter	= 5.4
Type	= 856 000 040.860